



END-TO-END CONICAL CONNECTION
SOLUTION FOR PREDICTABLE
AND ESTHETIC RESULTS

conipro 
complete

conipro
complete

CONICAL
CONNECTION
IMPLANT SYSTEMS

PROSTHETIC
SYNERGY



DIGITAL ENABLERS

ALL IN ONE KIT

END-TO-END CONICAL CONNECTION SOLUTION FOR PREDICTABLE AND ESTHETIC RESULTS

Alpha-Bio Tec's **ConiPro Complete**, is a simple to use, advanced end-to-end conical connection solution. Suitable for all clinical indications, from single tooth replacement to fully- edentulous, **ConiPro Complete** forges the ultimate connection between biological principles, and an esthetical approach.

A true 'one-stop' conical connection solution, **ConiPro Complete** seamlessly combines implants, surface selection, and prosthetics, Alpha-Bio Tec's surgical tool kit, and robust digital workflows.

ConiPro Complete manifests the Synergy between predictability & performance of our Conical connection Implant systems & our advanced prosthetic solutions.

CONICAL CONNECTION

SECURE CONNECTIONS FOR PREDICTABILITY & ESTHETICS

The ConiPro System enables the platform switching concept, contributing to the preservation of hard & soft tissue around the implant, which is crucial to the implant's stability & long-term success.

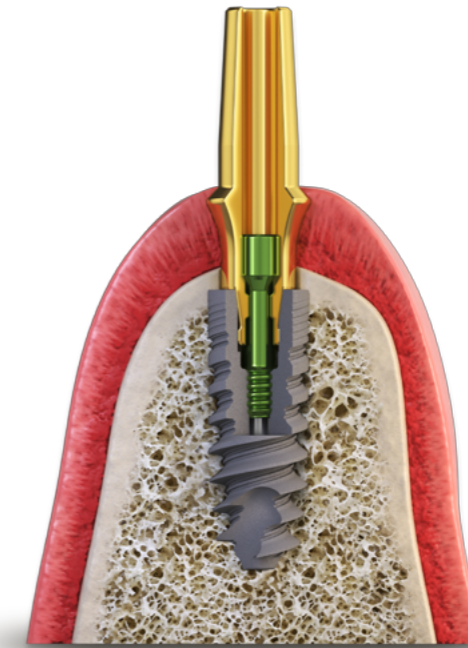

Alpha-Bio Tec. Conical Connection Implants have a conical shape connection to the abutment and are available in standard diameters (Ø 3.75 mm | Ø 4.2 mm | Ø 5 mm) & narrow diameters (Ø 3.2 mm | Ø 3.5 mm).

CONICAL CONNECTION

SECURE CONNECTIONS FOR PREDICTABILITY & ESTHETICS

- Enhanced platform switching
- Low bacterial leakage
- Reduced marginal bone loss
- Tight implant-abutment fit & minimal micromovements
- Long term esthetic results

CONICAL STANDARD CONNECTION

CS

Ø 3.75 mm | Ø 4.2 mm | Ø 5 mm



CONNECTION
Ø 3.1 mm



HEX
2.5 mm

CONICAL NARROW CONNECTION

CHC

Ø 3.2 mm | Ø 3.5 mm



CONNECTION
Ø 2.5 mm



HEX
2.1 mm

CONICAL CONNECTION IMPLANT SYSTEMS

MULTINEO™

MAXIMIZE ON IMMEDIACY

The MultiNeO implant is designed for immediate & delayed placement for a variety of procedures & clinical indications. The implant's stress relieving features contribute to reduced marginal bone loss & long-term esthetic results.



MULTINEO™ | POWERED BY NiNA

EMPOWERING PREDICTABILITY & PERFORMANCE IN IMMEDIACY

The MultiNeO powered by NiNA implant embodies the synergy between an innovative implant and an advanced nano hydrophilic surface. The innovative NiNA surface accelerates blood attraction and healing time, enabling increased bone support (BIC).

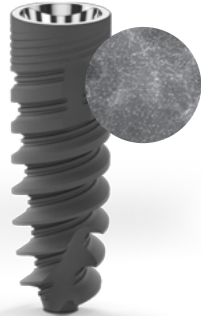

DFI™

A CYLINDRICAL IMPLANT YOU CAN RELY UPON WITH CONFIDENCE

The legacy implant, DFI, is a cylindrical shaped implant with a slightly tapered apex, suitable for a variety of clinical indications. From a single tooth to full arch restoration, the DFI implant is easily stabilized & controlled during placement & enables you to achieve long-term stability & high clinical survival rates.



CONICAL CONNECTION IMPLANT SYSTEMS

PREDICTABILITY & CONFIDENCE FOR A VARIETY OF CLINICAL INDICATIONS IN ALL BONE TYPES



SURFACE TECHNOLOGY

SURFACE TREATMENT FOR ENHANCED PREDICTABILITY & CLINICAL SUCCESS

Alpha-Bio Tec. mechanical & chemical surface treatment processes increase the implant surface area, enhance bone to implant contact & contribute to high survival rates.

NANOTEC™

NanoTec micron level implant surface is achieved through a mechanical & chemical surface modification process, which involves sandblasting and double thermal acid etching, for the creation of micropores (sized 1-5 microns).

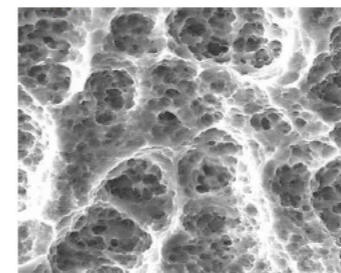

Micro level X 3k

The NanoTec process creates a high surface area, greatly influences the initial contact with the host bone and contributes to:

- Excellent osseointegration
- High long-term BIC (Bone to Implant Contact)
- Increased secondary stability

NiNA NANO HYDROPHILIC SURFACE

The innovative super-hydrophilic nanostructure surface consists of multiple levels:

- The basic micron level (1-5 microns) produced from the known and trusted sandblasted and acid etched treatment
- New innovative TiO₂ (Titanium Oxide) structures on the nanometric level
- A protective layer deployed on the implant to maintain the titanium's natural hydrophilic properties

Visible nanoscale TiO₂ structures increase surface area and actively promote osteoblast bone formation. The active attraction of osteoblasts, combined with surface hydrophilicity, enhances a biological response accelerating wound healing processes & increased BIC for enhanced confidence & predictability.

Micro level

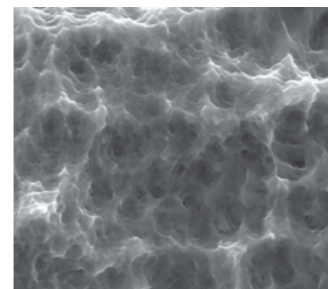

(A) Micro level X 15k

Nano level

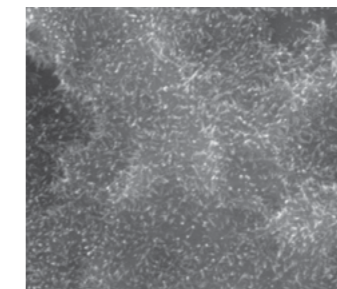

(B) Nano Level X 200k with nanostructures

SEM images: 15K magnification of a sandblasted and acid-etched implant (A) vs. 200K magnification of NiNA surface treatment (B), demonstrating TiO₂ structures growth.

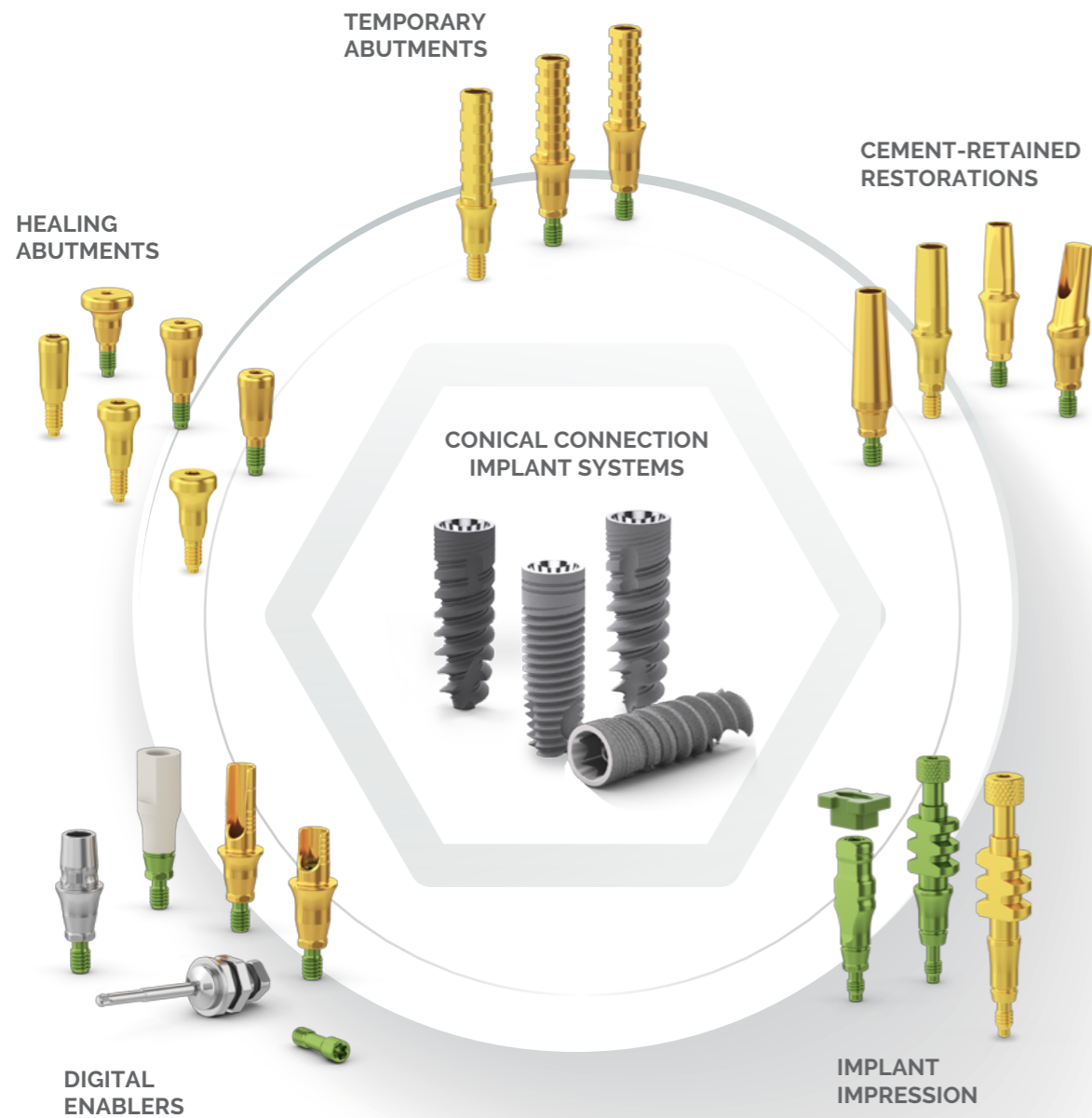

**END-TO-END CONICAL CONNECTION
SOLUTION FOR PREDICTABLE
AND ESTHETIC RESULTS**

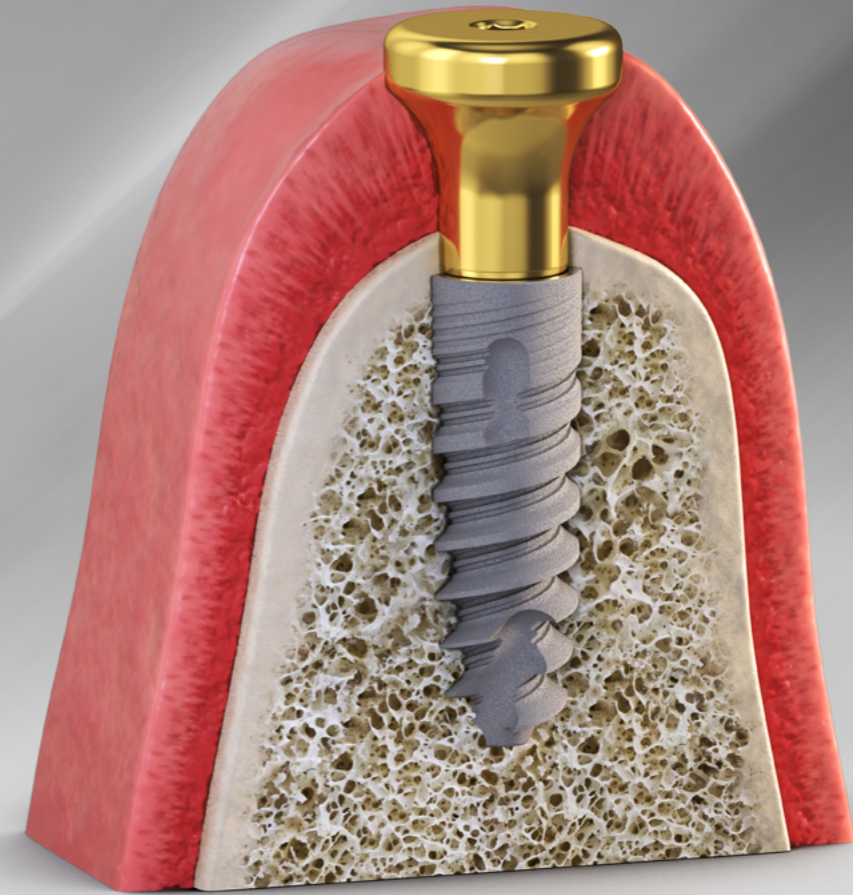

PROSTHETIC SOLUTIONS ENGINEERED HARMONY, CONICAL SYNERGY

The ConiPro complete prosthetic system is designed for optimal soft tissue management & high esthetics & includes healing abutments, open and closed tray transfers, temporary & cement retained abutments & CAD/CAM components.



New concave emergence profile & gold anodization



A wide range of gingival heights with shared emergence profile



Designed for subcrestal implant placement



Comprehensive restoration process with high esthetic results

PROSTHETIC SOLUTIONS

ENGINEERED HARMONY, CONICAL SYNERGY



HEALING ABUTMENTS

- Available diameters:
CS \varnothing 3.5mm, \varnothing 4.3mm & \varnothing 5.7mm
CHC \varnothing 2.7mm, \varnothing 3.8mm & \varnothing 4.2mm
- Wide range of gingival heights
- Suitable for cases of subcrestal implant placement
- Simple restoration process
- High esthetic results



PROSTHETIC SOLUTIONS

ENGINEERED HARMONY, CONICAL SYNERGY



OPEN AND CLOSED TRAY TRANSFERS

- New and improved design for ease-of-use
- Rotational & anti-rotational configurations for open tray transfers
- Marking groove for accurate placement and positioning
- Closed tray transfer with new snap cap

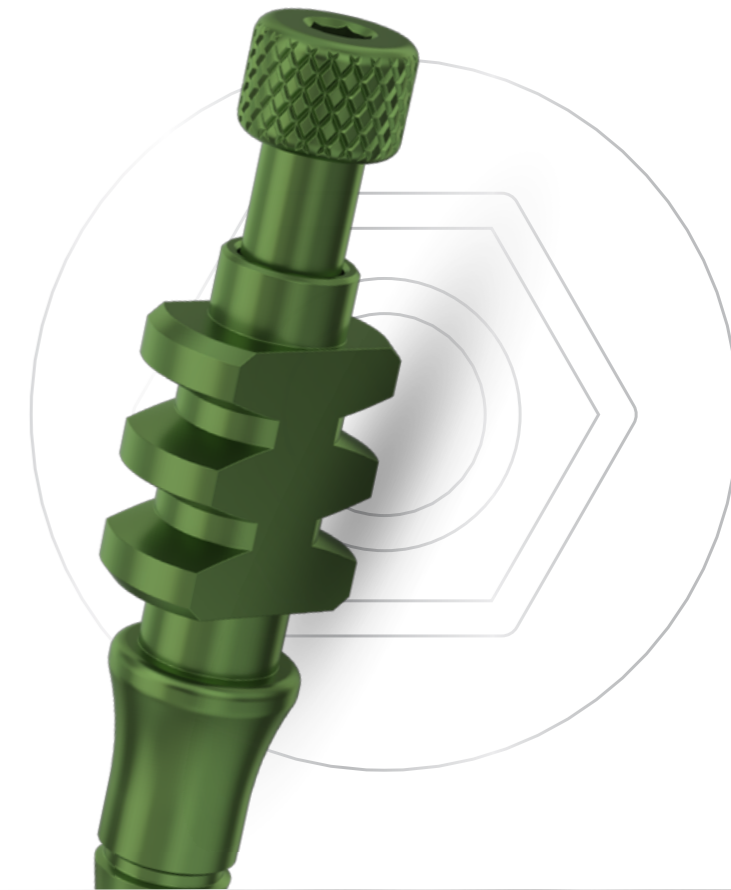

TEMPORARY ABUTMENTS

- Wide range of gingival heights
- Rotational and Anti Rotational configurations
- Suitable for cases of subcrestal implant placement
- Deep grooves
- Gold anodized
- High esthetic results

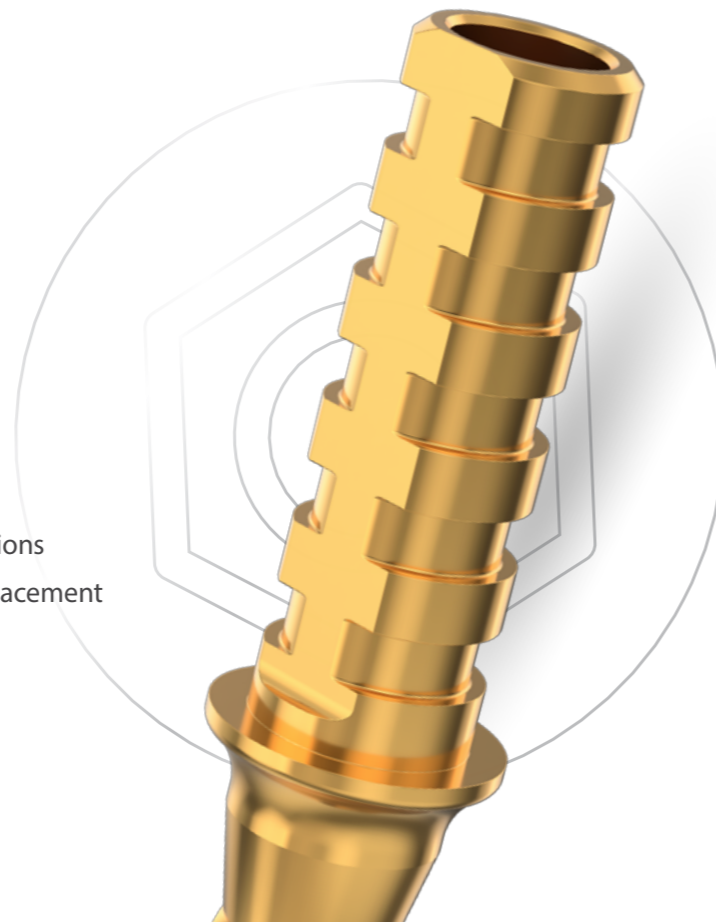

CEMENT-RETAINED RESTORATIONS STRAIGHT & ANGLED TITANIUM ABUTMENTS

- Wide range of gingival heights
- Suitable for cases of subcrestal implant placement
- Gold anodized
- High esthetic results



Note: All prosthetic components are compatible with 1.25mm prosthetic drivers.

■ For the full concave prosthetics portfolio, see pages 18-25

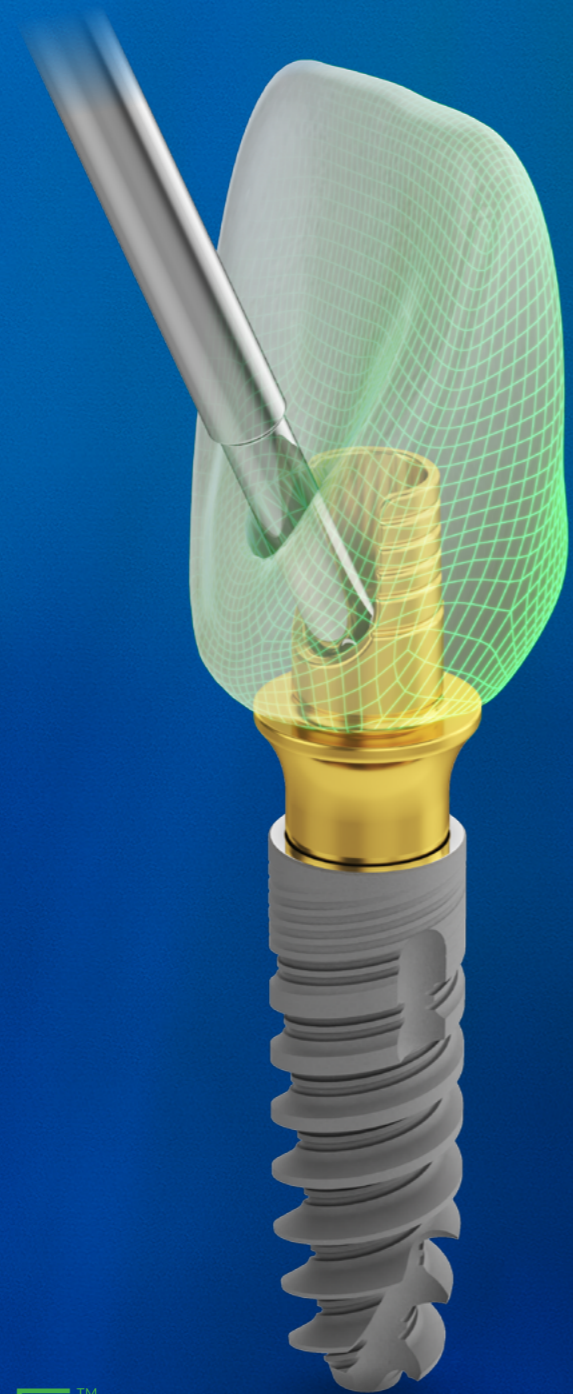

Screw-retained implant-supported restorations have proven advantages over cement-retained restorations, such as retrievability, no risk of residual cement & fewer biological complications. However, it is not always possible to place implants in the ideal angulation for screw retained restorations.

Alpha-Bio Tec's Omnibase abutments are designed to resolve this challenge.

The Omnibase is a Ti-Base used in CAD/CAM screw-retained restorations and enables the dental technician the flexibility to design a restoration with a screw access channel at a favorable position & angle (0°- 25°). This is particularly beneficial for improving esthetics, greater accessibility in the anterior region & in limited occlusal spaces.

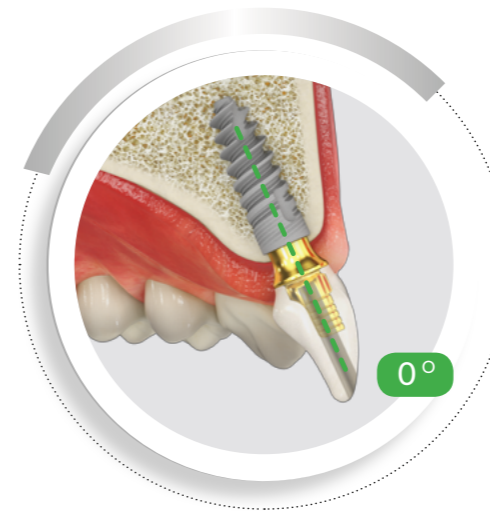

SCREW ACCESS CHANNEL AT 0°

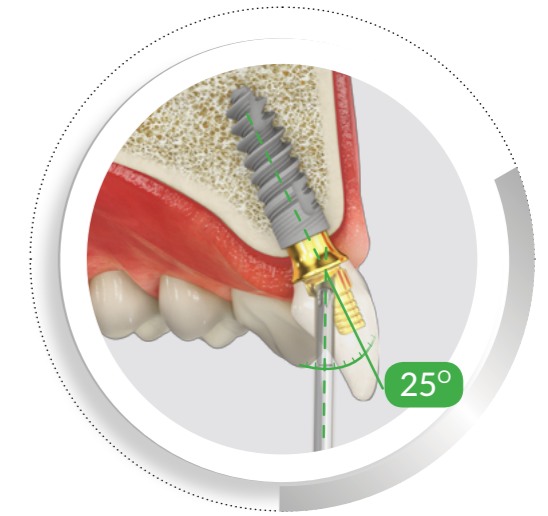

SCREW ACCESS CHANNEL AT A FAVORABLE POSITION 25°

OmniBASE™

EXPERIENCE FREEDOM FLEXIBILITY & ESTHETICS FROM A NEW ANGLE

The Omnibase Ti-Bases have a narrow concave emergence profile & are suitable for cases of subcrestal implant placement.

DESIGN FEATURES & CLINICAL BENEFITS

- Standard & customizable Ti-bases
- A wide range of gingival heights
- Retrievable screw for ease of use & maintenance
- New concave emergence profile & gold anodization
- Suitable for subcrestal implant placement
- High esthetic results

■ Supporting digital libraries: exocad™, 3shape™

■ For the full Omnibase system portfolio, see pages 26-29

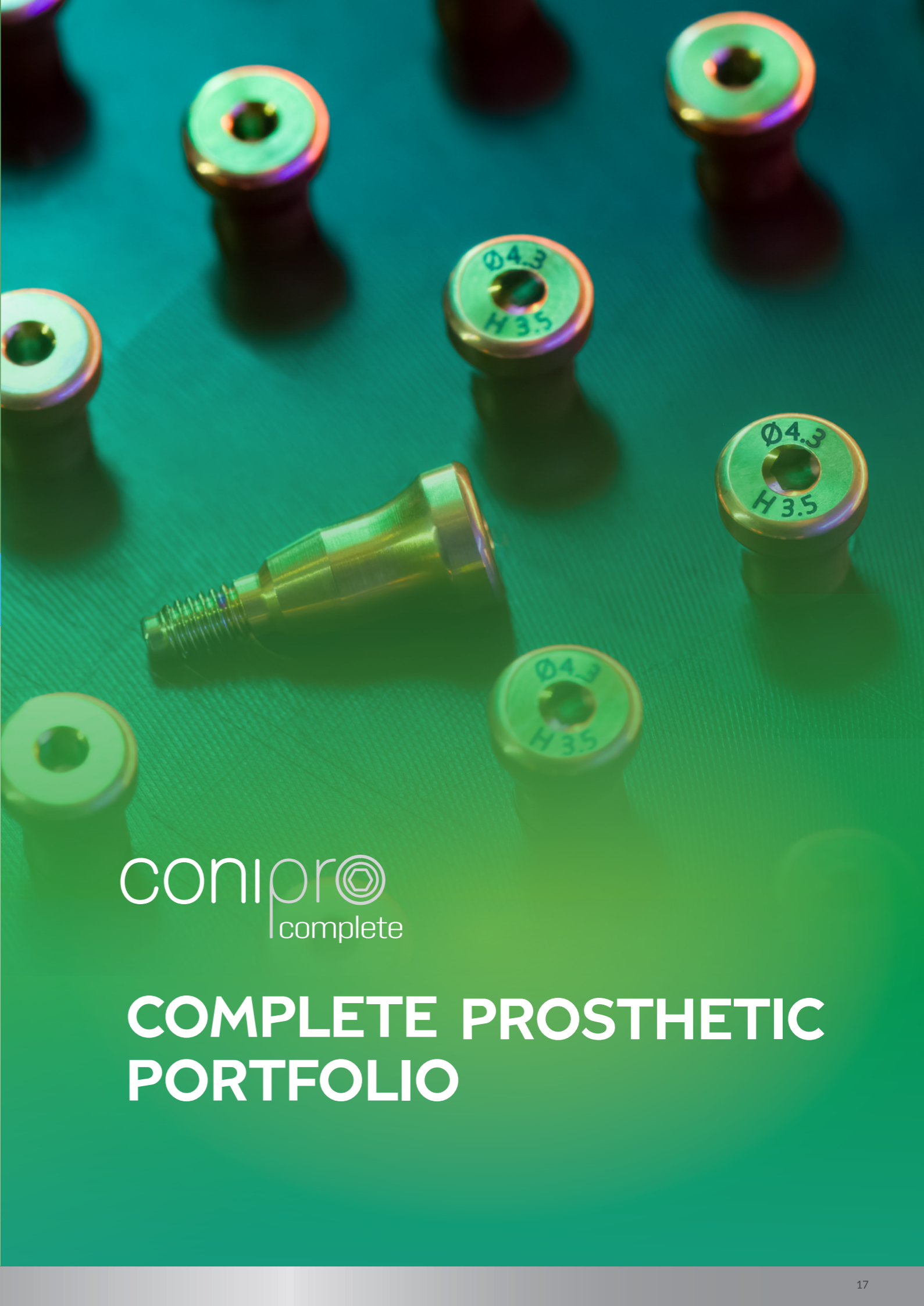

CONCAVE TI-BASES*

DESIGN FEATURES AND CLINICAL BENEFITS

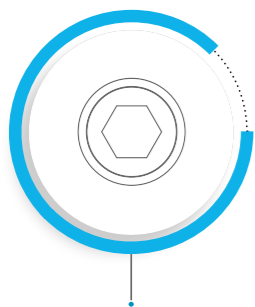

ENGAGED TI-BASES
FOR SINGLE TOOTH
RESTORATION

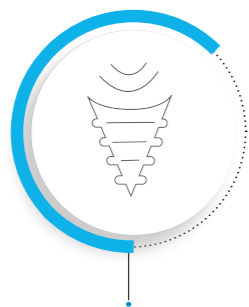

NARROW CONCAVE
EMERGENCE PROFILE

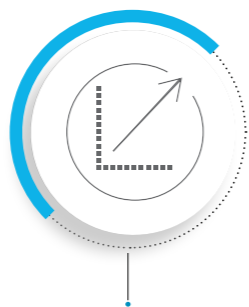

WIDE RANGE
OF GINGIVAL
HEIGHTS

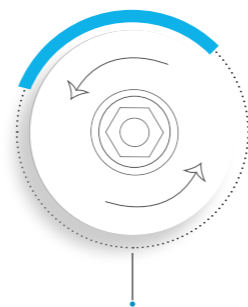

FOR CONICAL (CS & CHC)
CONNECTION IMPLANTS

Supporting digital libraries: exocad™, 3shape™

VISIT OUR WEBSITE TO DOWNLOAD ALPHA-BIO TEC.'S DIGITAL LIBRARIES FOR
CAD/CAM SYSTEMS

* Labeled as 'Sirona Ti-Bases'

For the full Concave Ti-Bases portfolio, see page 30



conipro[®]
complete

COMPLETE PROSTHETIC PORTFOLIO

HEALING ABUTMENTS



TEMPORARY ABUTMENTS



MANUAL
TIGHTENING
10 NCM

30
NCM

Ø 3.5

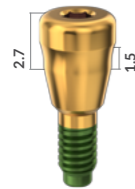

3931

Ø 3.5

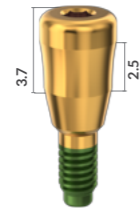

3932

Ø 3.5

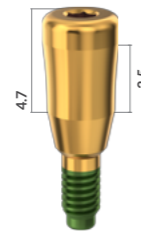

3933

Ø 3.5

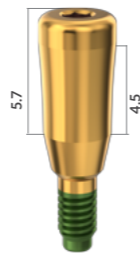

3934

Ø 3.5



3935

Ø 4.3

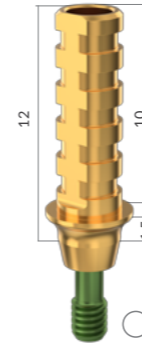

3901

Ø 4.3

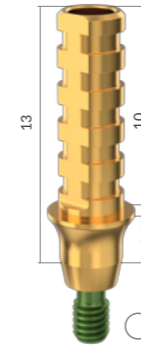

3902

Ø 4.3

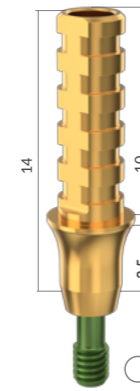

3903

Ø 4.3

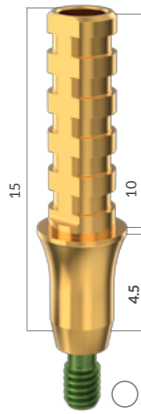

3904

Ø 4.3

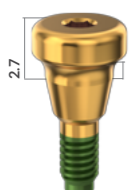

3941

Ø 4.3



3942

Ø 4.3

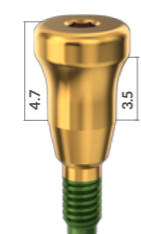

3943

Ø 4.3



3944

Ø 4.3

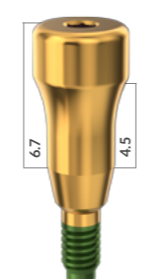

3945

Ø 4.3

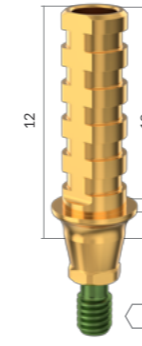

3911

Ø 4.3

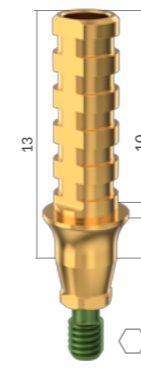

3912

Ø 4.3

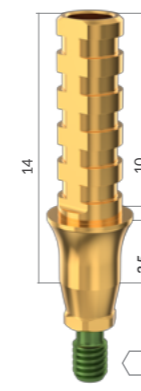

3913

Ø 4.3

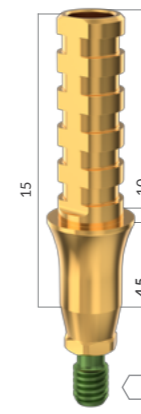

3914

Ø 3.4

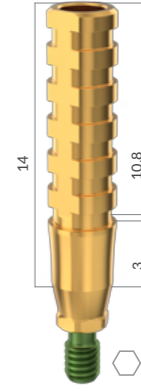

3915





MANUAL
TIGHTENING
10 NCM

CLOSED TRAY TRANSFER

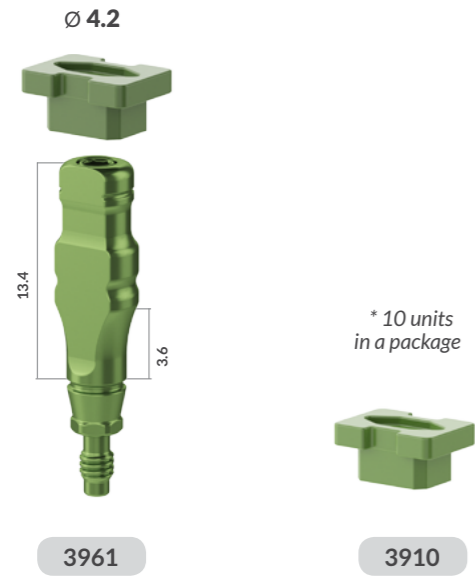

SCAN BODY



30
NCM

STRAIGHT TITANIUM ABUTMENTS

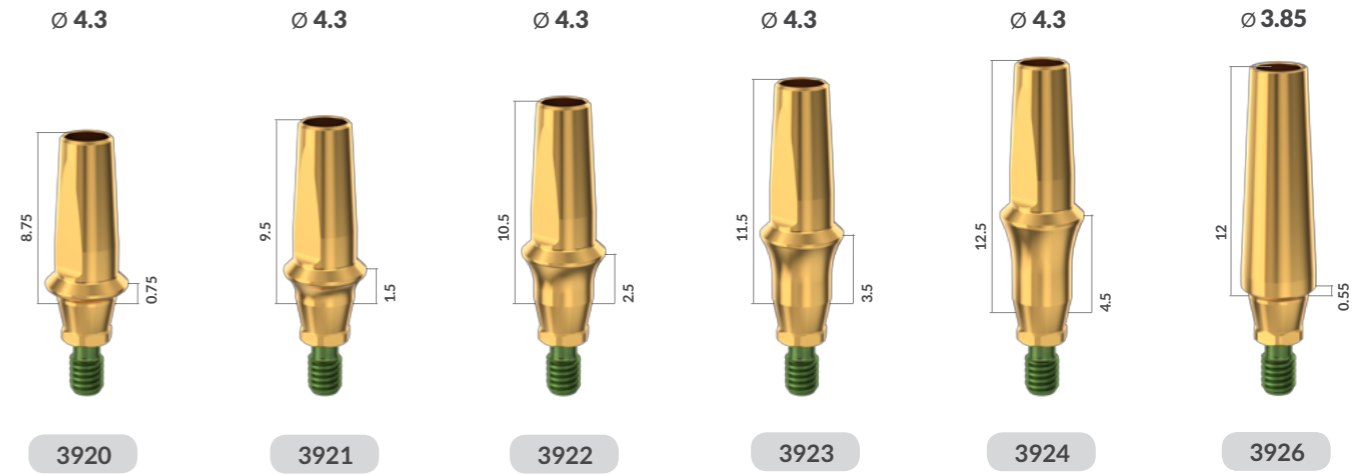

OPEN TRAY TRANSFERS

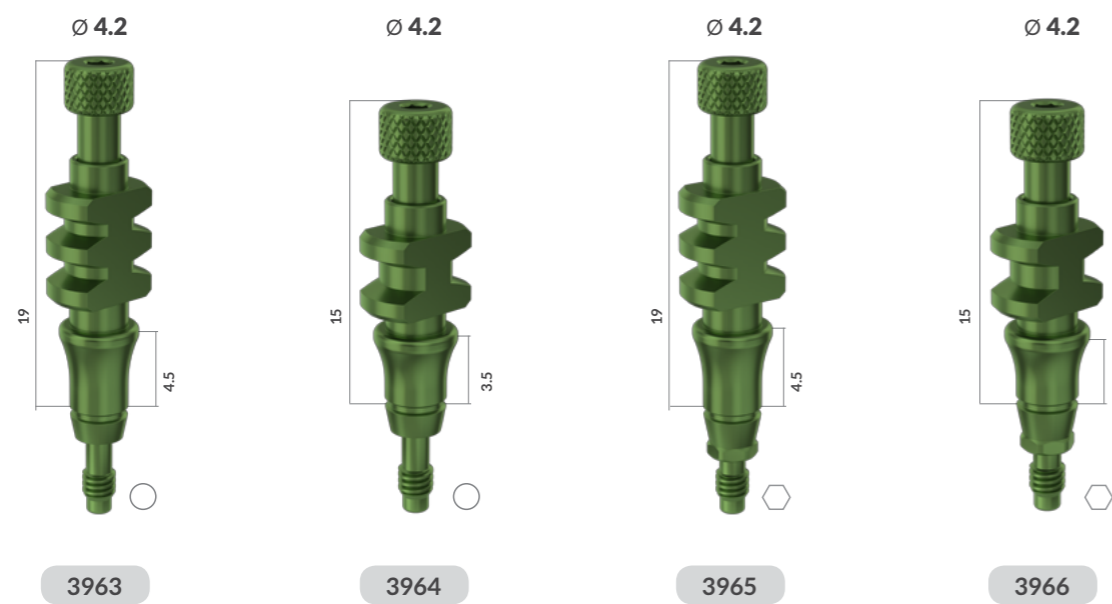

ANGLED TITANIUM ABUTMENTS

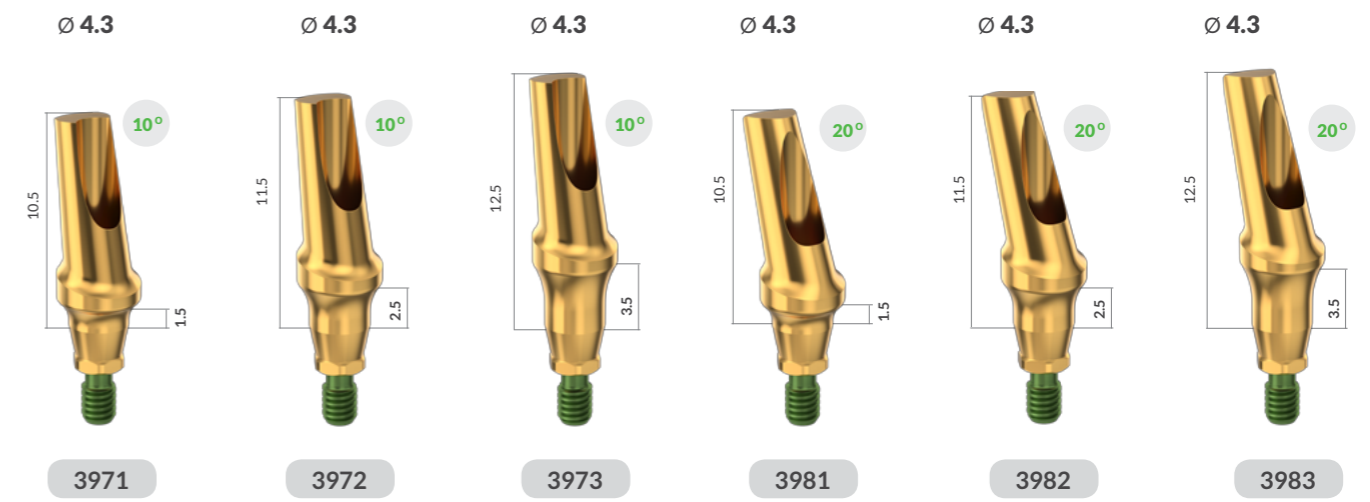

MANUAL
TIGHTENING
10 NCM

20
NCM

Ø 2.7



3351

Ø 2.7

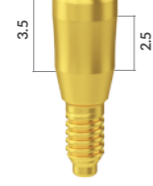

3352

Ø 2.7

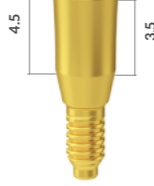

3353

Ø 2.7

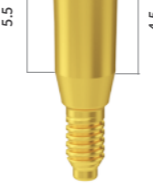

3354

Ø 2.7

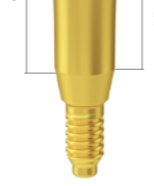

3355

Ø 3.8

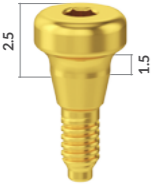

3361

Ø 3.8



3362

Ø 3.8

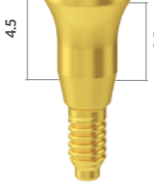

3363

Ø 3.8



3364

Ø 3.8



3365

Ø 4.2

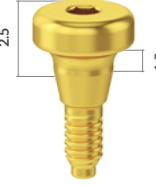

3341

Ø 4.2



3342

Ø 4.2



3343

Ø 4.2

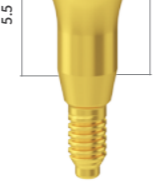

3344

Ø 4.2



3345

Ø 3.6

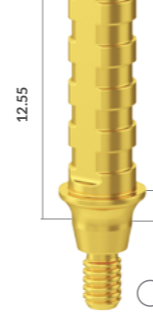

3301

Ø 3.6

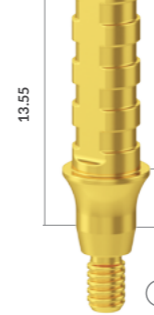

3302

Ø 3.6

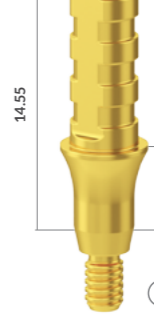

3303

Ø 3.6

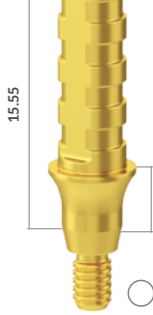

3304

Ø 3.6



3311

Ø 3.6

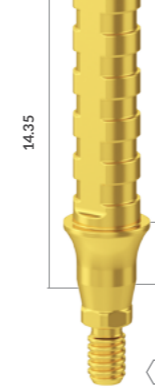

3312

Ø 3.6

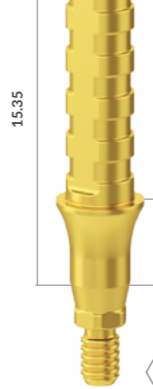

3313

Ø 3.6



3314

Ø 2.8



3309



MANUAL
TIGHTENING
10 NCM

20
NCM

CLOSED TRAY TRANSFER

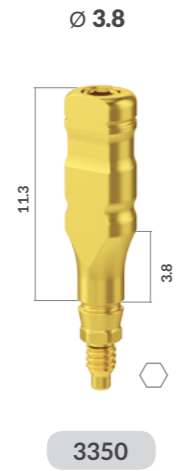

DUAL USE SCAN BODY



OPEN TRAY TRANSFERS

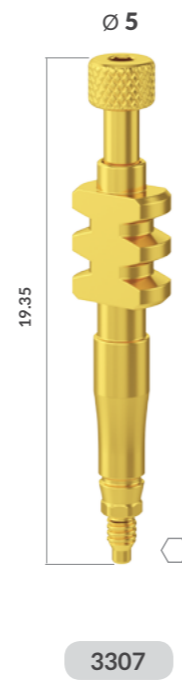
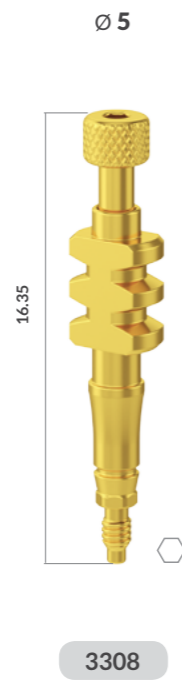
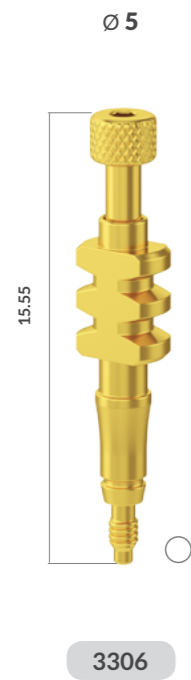

STRAIGHT TITANIUM ABUTMENTS

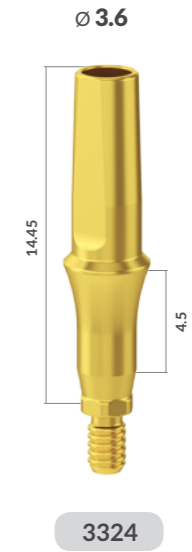
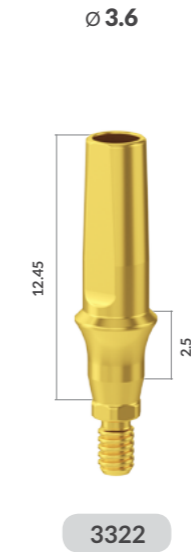
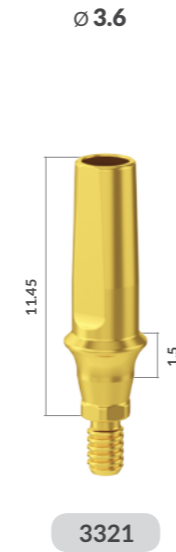
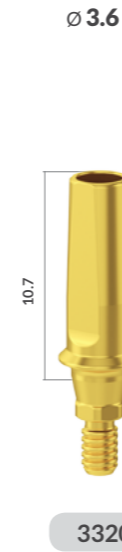

ANGLED TITANIUM ABUTMENTS

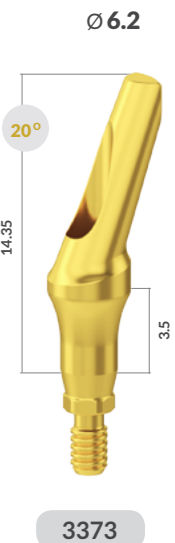
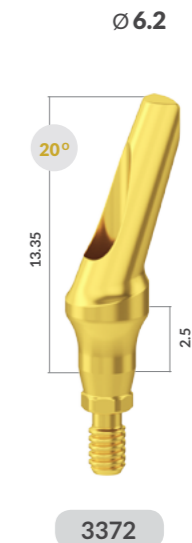
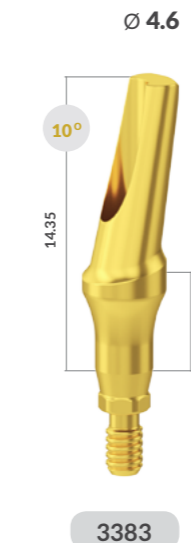
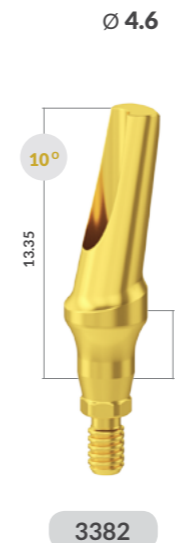
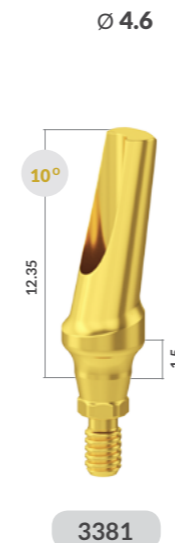



30 NCM
TIGHTENING
TORQUE

STANDARD TI-BASES

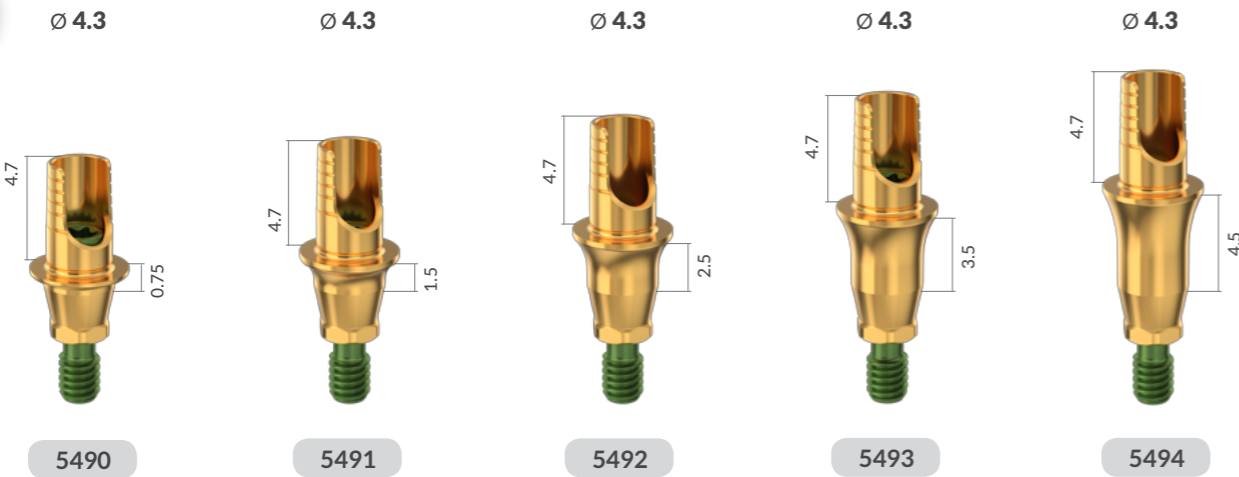

STANDARD OMNIBASES

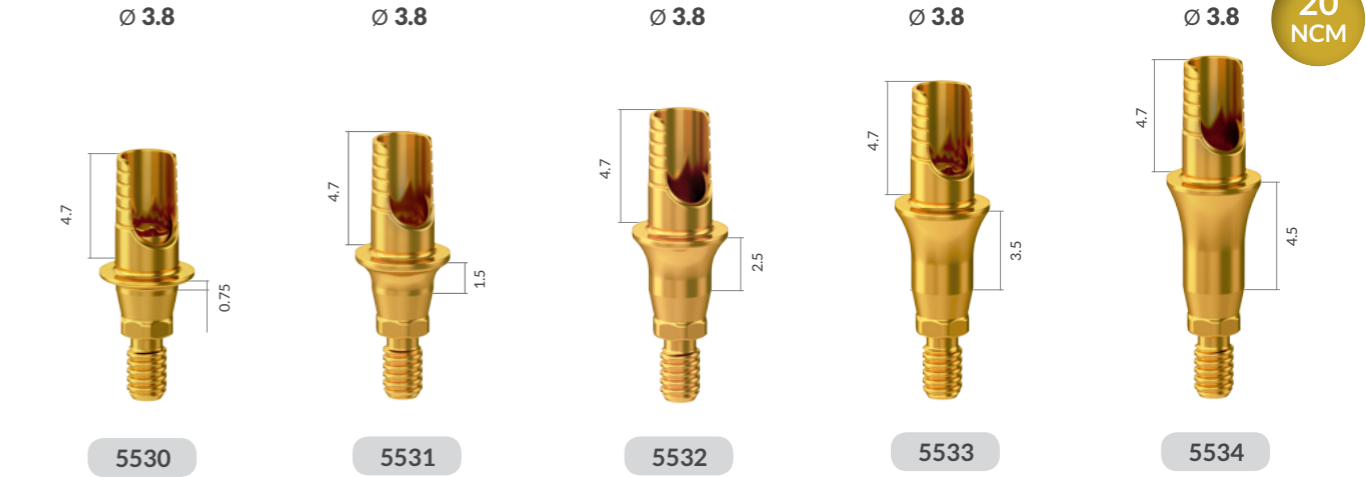

CUSTOMIZABLE TI-BASES

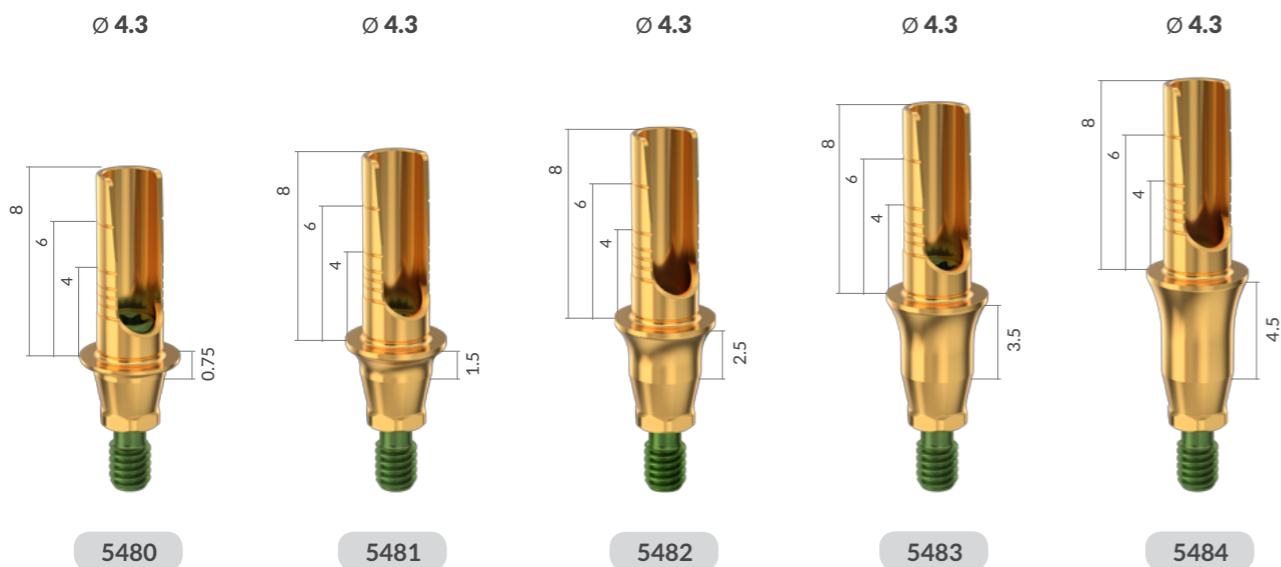

CUSTOMIZABLE TI-BASES

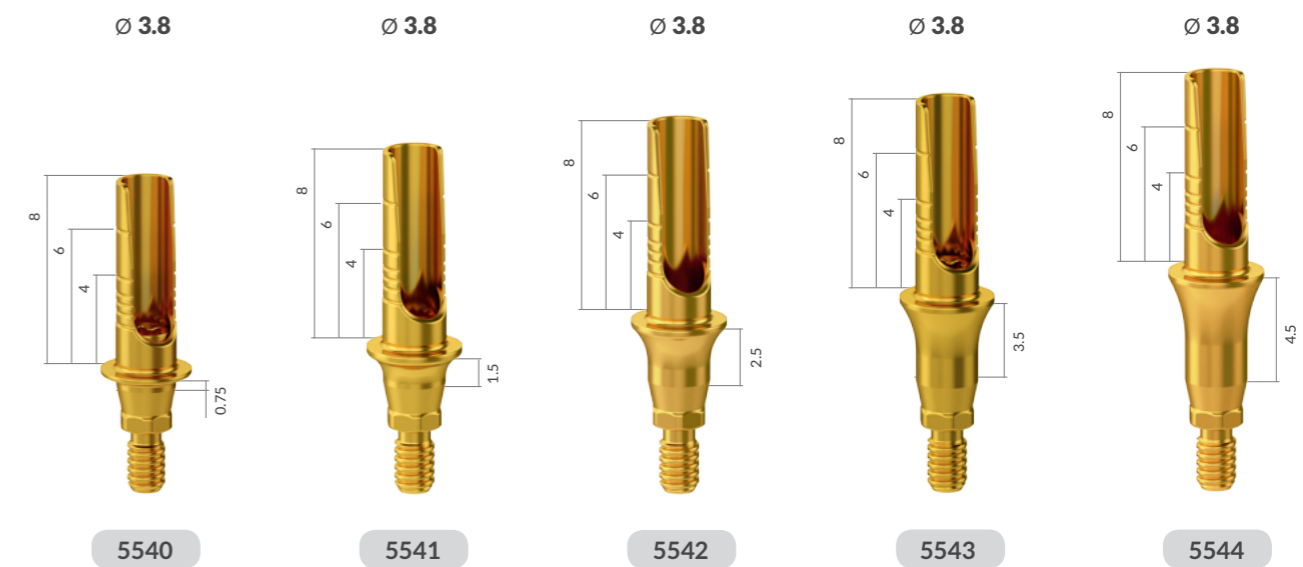

TX SCREWS

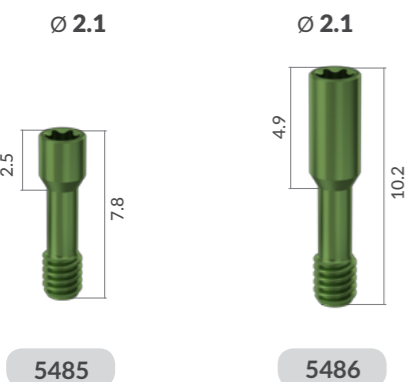

Note:

- Omnibase TX screw, Ref. # 5485 is to be used with Omnibases Ref. #: 5490, 5491, 5492, 5480, 5481 & 5482.
- Omnibase TX screw, Ref. # 5486 is to be used with Omnibases Ref. #: 5493, 5494, 5483 & 5484.

TX SCREWS



Note:

- Omnibase TX screw, Ref. # 5507 is to be used with Omnibases Ref. #: 5530, 5531, 5532, 5540, 5541 & 5542.
- Omnibase TX screw, Ref. # 5501 is to be used with Omnibases Ref. #: 5533, 5534, 5543 & 5544.

OmniBASE TX DRIVERS FOR INSERTION/REMOVAL AT 0° - 25°

EXPERIENCE FREEDOM: FLEXIBILITY & ESTHETICS FROM A NEW ANGLE



- Laser marking on top of the drivers for easy identification

MANUAL TX DRIVER
ANGLED STANDARD

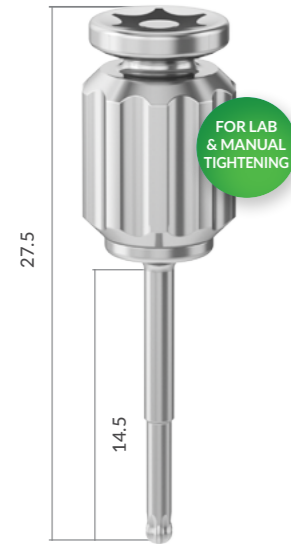

5475

RATCHET TX DRIVER
ANGLED STANDARD

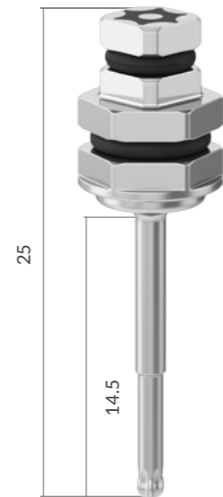

5548

MOTOR TX DRIVER
ANGLED STANDARD

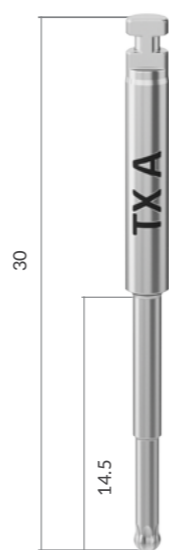

5477

MANUAL TX DRIVER
ANGLED LONG

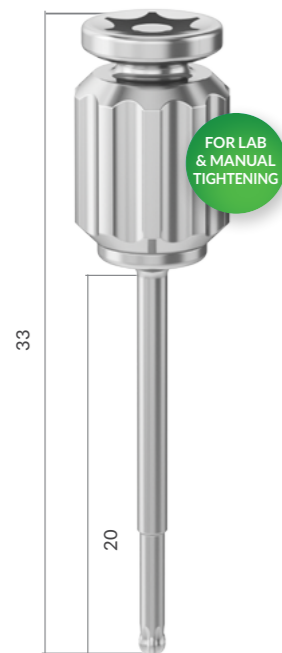

5546

RATCHET TX DRIVER
ANGLED LONG

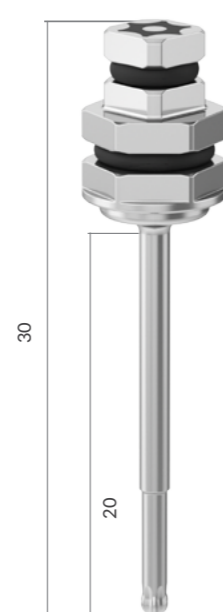

5476

MOTOR TX DRIVER
ANGLED LONG

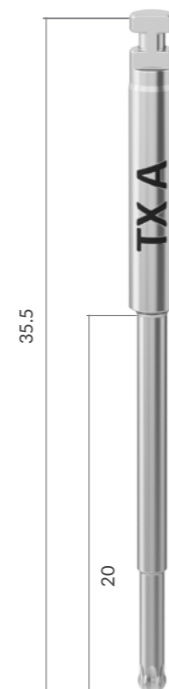

5547

OmniBASE TX DRIVERS FOR VERTICAL INSERTION/REMOVAL AT 0°

EXPERIENCE FREEDOM: FLEXIBILITY & ESTHETICS FROM A NEW ANGLE

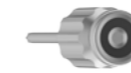

- Laser marking on top of the drivers for easy identification

MANUAL STANDARD TX DRIVER
FOR VERTICAL INSERTION

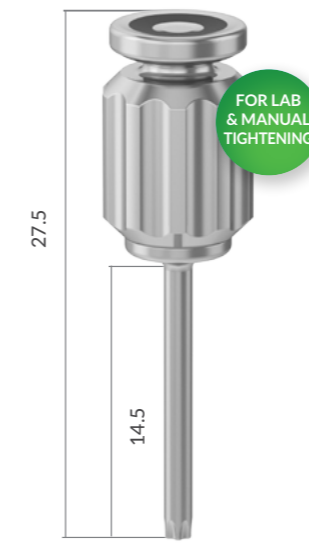

5478

RATCHET STANDARD TX DRIVER
FOR VERTICAL INSERTION

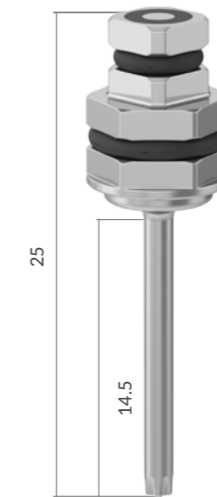

5496

MOTOR STANDARD TX DRIVER
FOR VERTICAL INSERTION

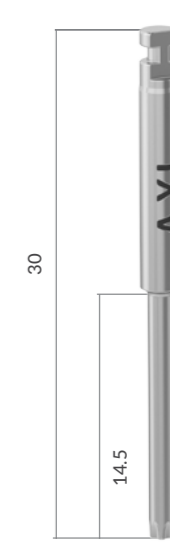

5498

MANUAL LONG TX DRIVER
FOR VERTICAL INSERTION

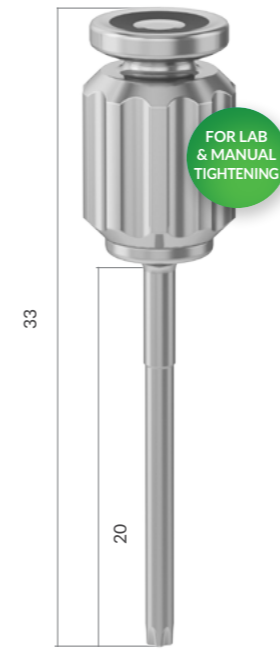

5479

RATCHET LONG TX DRIVER
FOR VERTICAL INSERTION

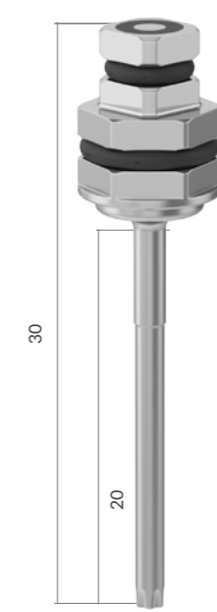

5497

MOTOR LONG TX DRIVER
FOR VERTICAL INSERTION

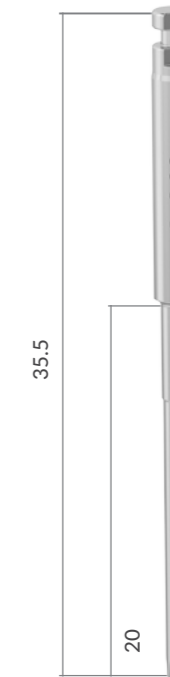

5495

CONCAVE TI-BASES



COMPLETE CONICAL CONNECTION SYSTEM SEAMLESSLY CONNECTED WORKFLOW

30 NCM
TIGHTENING
TORQUE

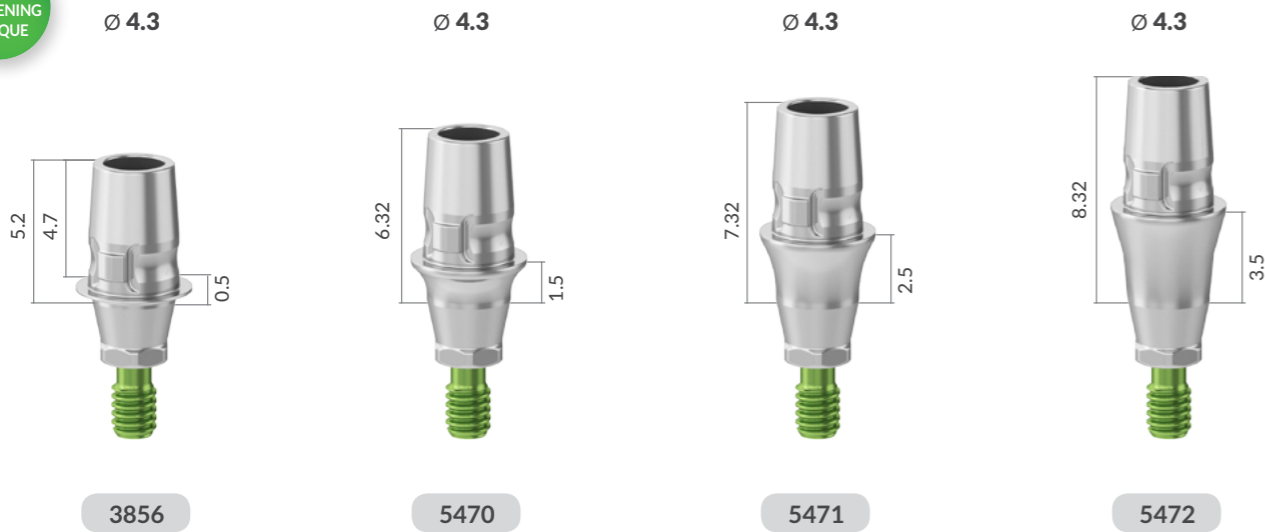

CLASSICAL CONICAL CONNECTION PROSTHETIC LINE



FOR THE FULL RANGE OF OUR CONICAL PROSTHETIC SOLUTIONS & SIRONA TI-BASES, DOWNLOAD ALPHA-BIO TEC. PRODUCT CATALOG:

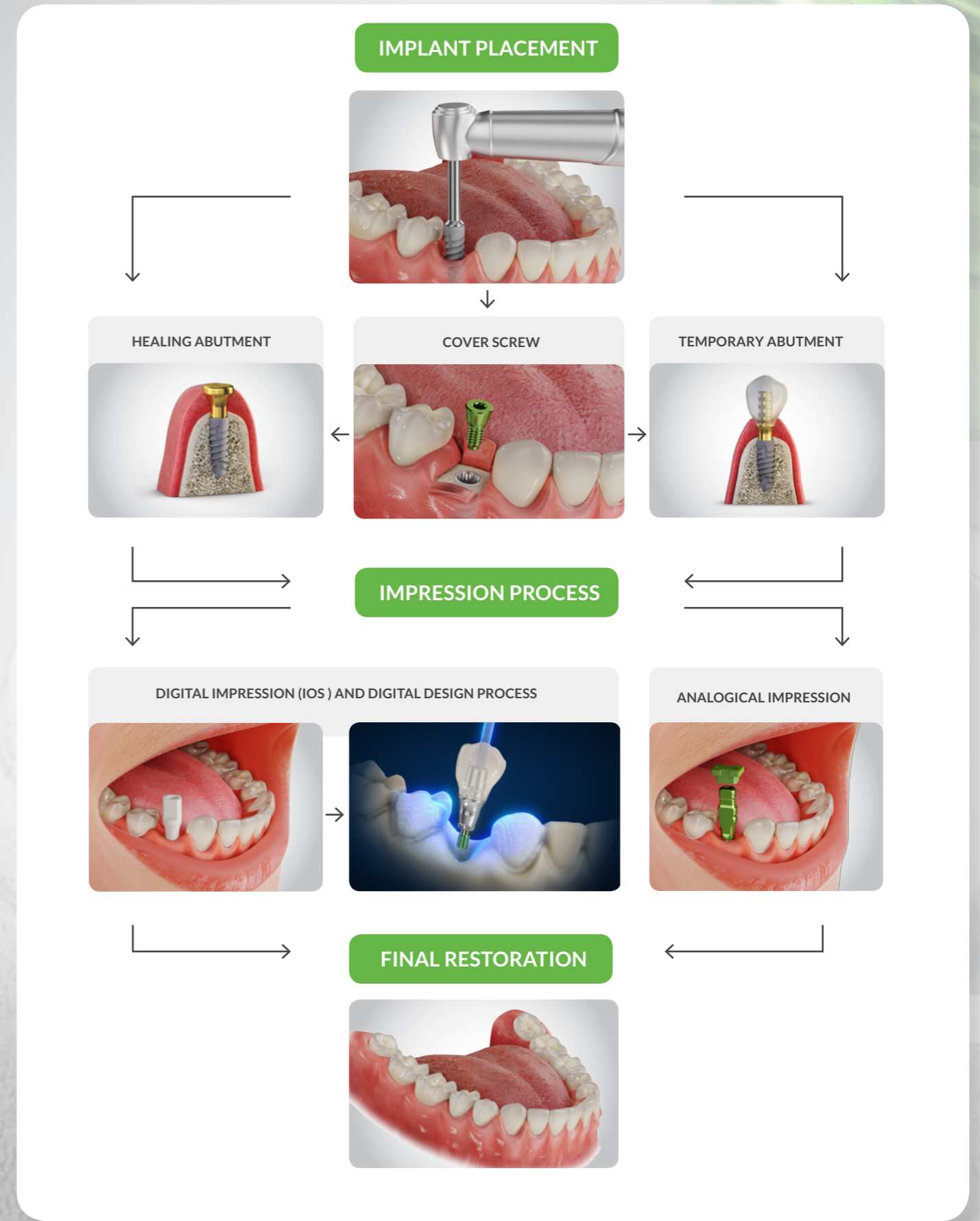



995-0444 R2/02.2025



Alpha-Bio Tec's products are CE-marked in accordance with the EU Medical Device Regulation MDR 2017/745 of 5 April 2017.

Alpha-Bio Tec's complies with EN ISO 13485:2016. Product availability may vary between countries.

www.alpha-bio.net